

COMPONENTI E ORGANI DI TRASMISSIONE
TRANSMISSION COMPONENTS AND COUPLINGS

	Descrizione - Description		Type	Page
	SEMIGIUNTO DENTATO <i>SPLINED COUPLING</i>		BF	340
	GIUNTO ELASTICO <i>FLEXIBLE COUPLING</i>		HE	341
	LANTERNA PER MOTORE ELETTRICO <i>BELL-HOUSING TO CONNECT ELECTRIC MOTOR</i>		HL	342
	SUPPORTO TIROCINGHIA <i>BELT PULLEY SUPPORT</i>		STSU	342
	MULTIPLICATORE PER POMPA <i>P.T.O. GEAR BOX FOR PUMP</i>	GR.2 GR.3	GBML32 GBML52	343
	NEW! RIDUTTORE - SAE A <i>REDUCTION GEAR - SAE A</i>	GR.2 GR.3	GBR2 GBR3	344

BF

SEMIGIUNTO DENTATO
SPLINED COUPLING

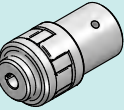
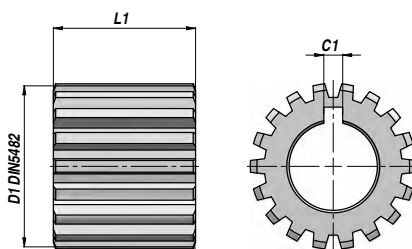

Codice Code	Tipo Type	Pompa Pump	C1	D1 DIN 5482	Nr. denti Teeth Nr.	Conicità Taper	L1	kg
BF31000400	BF1-1	GR.1	2.40	20x17	12		14.5	0,02
BF31001000	BF2/1-1	GR.1	2.40	25x22	14		14.5	0,02
BF31000700	BF2	GR.2	3.17	"	"		22.0	0,03
BF31000800	BF2T	GR.2T	4.00	"	"		22.5	0,04
BF31001900	BF2 Z15	GR.2	3.17	28x25	15		22.0	0,05
BF31002000	BF2T Z15	GR.2T	4.00	"	"		22.5	0,06
BF31003300	BF2.5/2	GR.2	3.17	32x28	17		22.0	0,08
BF31003000	BF2.5/2T	GR.2T	4.00	"	"		22.5	0,08
BF31002300	BF2.5	GR.2.5	4.00	"	"		26.0	0,07
BF31003900	BF3/2	GR.2	3.17	35x31	18		22.0	0,11
BF31004000	BF3/2T	GR.2T	4.00	"	"	1:8	22.5	0,11
BF31003500	BF3	GR.3	4.00	"	"		26.0	0,10
BF31005600	BF3.5/2	GR.2	3.17	40x36	20		22.0	0,15
BF31006200	BF3.5/2T	GR.2T	4.00	"	"		22.5	0,15
BF31005800	BF3.5/3	GR.3	4.00	"	"		26.0	0,15
BF31005400	BF3.5	GR.3.5	4.80	"	"		32.0	0,16
BF31007000	BF4/2	GR.2	3.17	48x44	23		22.0	0,24
BF31007100	BF4/2T	GR.2T	4.00	"	"		22.5	0,24
BF31007200	BF4/3	GR.3	4.00	"	"		26.0	0,26
BF31007300	BF4/3.5	GR.3.5	4.80	"	"		32.0	0,30
BF31006600	BF4	GR.4	6.40	"	"		42.0	0,29

MATERIALE : ACCIAIO
MATERIAL : STEEL

GIUNTO ELASTICO
FLEXIBLE COUPLING

HE

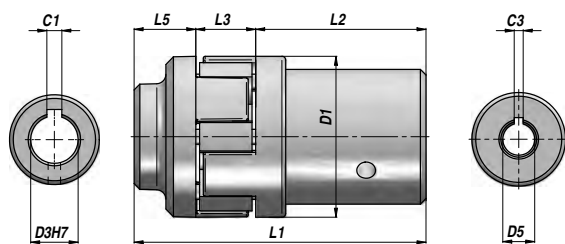

Codice Code	Tipo Type	D1	L1	Motore Elettrico - Electric Motor					L3	Pompa - Pump				kg
				kW	ØD3	C1	L2	GR.		D5	C3	L5		
BH10200002	HE2	43	62.0	0.25 - 0.37	14	5	29.5	16	GR.1	1:8	2.4	16.5	0,12	
BH10200020	HE22	43	81.0	0.55 - 0.75	19	6	45.5	16	GR.T05	∅7	2.0	19.5	0,16	
BH10200006	HE6	43	78.0	"	"	6	45.5	16	GR.1	1:8	2.4	16.5	0,16	
BH10200042	HE46	63	85.5	"	"	6	44.5	19	GR.2	1:8	3.2	22.0	0,32	
BH10200043	HE47	63	85.5	"	"	6	44.5	19	GR.2T	1:8	4.0	22.0	0,32	
BH10200037	HE41	63	78.0	1.10 - 1.50	24	8	36.0	19	GR.1	1:8	2.4	23.0	0,30	
BH10200012	HE14	63	85.5	"	"	8	44.5	19	GR.2	1:8	3.2	22.0	0,34	
BH10200013	HE15	63	85.5	"	"	8	44.5	19	GR.2T	1:8	4.0	22.0	0,34	
BH10200014	HE16	63	106.5	2.20 - 3 - 4	28	8	64.5	19	GR.1	1:8	2.4	23.0	0,43	
BH10200017	HE19	63	105.5	"	"	8	64.5	19	GR.2	1:8	3.2	22.0	0,44	
BH10200018	HE20	63	105.5	"	"	8	64.5	19	GR.2T	1:8	4.0	22.0	0,44	
BH10200084	HE48	63	119.5	"	"	8	64.5	19	GR.3	1:8	4.0	36.0	0,48	
BH10200024	HE28	86	134.0	5.50 - 7.50	38	10	79.0	23	GR.2	1:8	3.2	32.0	0,86	
BH10200025	HE29	86	134.0	"	"	10	79.0	23	GR.2T	1:8	4.0	32.0	0,86	
BH10200026	HE30	86	134.0	"	"	10	79.0	23	GR.3	1:8	4.0	32.0	0,93	
BH10200027	HE31	86	133.5	"	"	10	79.0	23	GR.3.5	1:8	4.8	31.5	0,91	
BH10200028	HE32	110	174.0	11 - 15	42	12	105.0	27	GR.2	1:8	3.2	42.0	1,54	
BH10200029	HE33	110	174.0	"	"	12	105.0	27	GR.2T	1:8	4.0	42.0	1,54	
BH10200030	HE34	110	174.0	"	"	12	105.0	27	GR.3	1:8	4.0	42.0	1,57	
BH10200031	HE35	110	174.0	"	"	12	105.0	27	GR.3.5	1:8	4.8	42.0	1,56	
BH10200032	HE36	110	174.0	"	"	12	105.0	27	GR.4	1:8	6.4	42.0	1,60	
BH10200033	HE37	110	174.0	18.50 - 22	48	14	105.0	27	GR.3	1:8	4.0	42.0	1,61	
BH10200034	HE38	110	174.0	"	"	14	105.0	27	GR.3.5	1:8	4.8	42.0	1,60	
BH10200035	HE39	110	174.0	"	"	14	105.0	27	GR.4	1:8	6.4	42.0	1,73	

MATERIALE : ALLUMINIO
MATERIAL : ALUMINIUM

HL

LANTERNA PER MOTORE ELETTRICO
BELL-HOUSING TO CONNECT ELECTRIC MOTOR

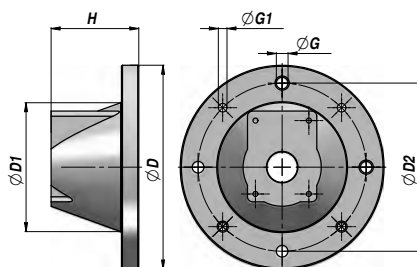
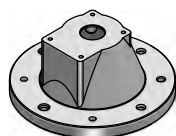

Codice Code	Tipo Type	ØD	Motore Elettrico Electric Motor kW	Pompa Pump	ØD1	H	ØG	ØG1	ØD2	kg
AH30100200	HL2	160	0.27 - 0.37	GR.1	110	70	9.0	M8	130	0,44
AH30202800	HL5L	200	0.55 - 0.75 - 1.1 - 1.5	GR.1	130	86	11.5	M10	165	0,67
AH30203500	HL7SL	"	"	GR.2/2T	130	95	11.5	M10	165	0,65
AH30302500	HL8/1L	250	2.2 - 3 - 4	GR.1	176	115	13.0	M12	215	1,22
AH30302600	HL9L	"	"	GR.2/2T	176	115	13.0	M12	215	1,21
AH15050005	HL11	"	"	GR.3	176	130	13.0	M12	215	1,20
AH30400800	HL12	300	5.5 - 7.5	GR.2/2T	229	148	13.0	M12	265	1,99
AH30400900	HL13	"	"	GR.3	229	148	13.0	M12	265	1,99
AH15000001	HL15	350	11 - 15	GR.2/2T	210	187	18.0	ø18	300	3,38
AH30509200	HL16	"	11 - 15 - 18.5 - 22	GR.3	210	187	18.0	ø18	300	3,38

DISPONIBILI ANCHE CON ANELLO DI RIDUZIONE - ALSO AVAILABLE WITH ADAPTER RING

MATERIALE : ALLUMINIO
MATERIAL : ALUMINIUM

STSU

SUPPORTO TIROCINGHIA
BELT PULLEY SUPPORT

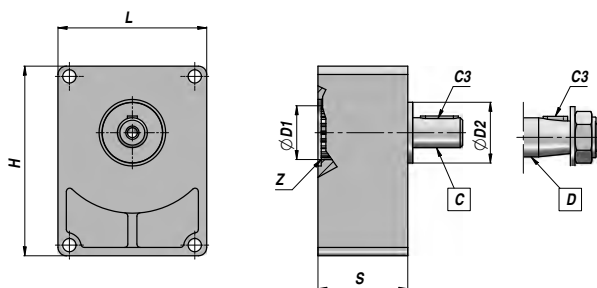
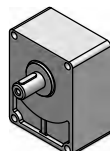

Codice Code	Tipo Type	Pompa Pump	ØD1	Z DIN 5482	ØD2	Albero Shaft	C3	L	H	S	kg
BU12010002	STSU/1 - C	GR.1	25.4	Z14 - 25x22	50.8	C = ø18	6x6x25	75.0	93.0	40.0	0,80
BU12020001	STSU/2 - C	GR.2	36.5	Z14 - 25x22	36.5	C = ø18	6x6x30	89.4	114.0	54.5	1,40
BU12020007	STSUR/2 - C	GR.2	36.5	Z15 - 28x25	50.8	C = ø22	6x6x40	89.4	114.0	52.0	1,75
BU12030001	STSU/3 - C	GR.3	50.8	Z18 - 35x31	50.8	C = ø24	8x7x40	123.5	153.2	52.0	2,20
BU12010001	STSU/1 - D	GR.1	25.4	Z14 - 25x22	50.8	D = Conico Tapered 1:8	4 x 6.5	75.0	93.0	40.0	0,80
BU12020004	STSU/2 - D	GR.2	36.5	Z14 - 25x22	36.5		4 x 6.5	89.4	114.0	54.5	1,40
BU12020008	STSUR/2 - D	GR.2	36.5	Z15 - 28x25	50.8		4 x 6.5	89.4	114.0	52.0	1,75
BU12030002	STSU/3 - D	GR.3	50.8	Z18 - 35x31	50.8		4 x 7.5	123.5	153.2	52.0	2,20

MATERIALE CORPO : ALLUMINIO
BODY MATERIAL : ALUMINIUM

MOLTIPLICATORE PER POMPA GR.2
P.T.O. GEAR BOX FOR GR.2 PUMP

GBML32

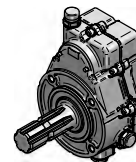
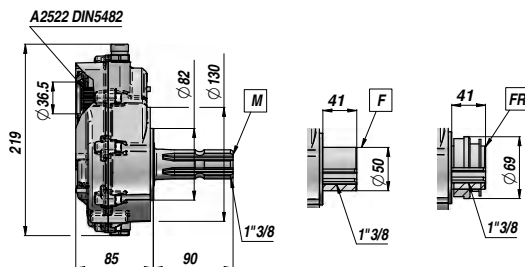

Codice Code	Tipo Type	Albero - Shaft		Rapporto Ratio	kg
		Ingresso - Input	Uscita - Output		
BM60001010	GBML32 - M - 1 / 1.5	Maschio Male 1"3/8 SAE J 1170	Femmina Female A 25x22 DIN 5482	1.5	5,30
BM60001020	GBML32 - M - 1 / 2.0			2.0	5,30
BM60001030	GBML32 - M - 1 / 2.5			2.5	5,30
BM60001040	GBML32 - M - 1 / 3.0			3.0	5,30
BM60001050	GBML32 - M - 1 / 3.5			3.5	5,30
BM60001060	GBML32 - M - 1 / 3.8			3.8	5,30
BM60002010	GBML32 - F - 1 / 1.5	Femmina Female 1"3/8 SAE J 1170	Femmina Female A 25x22 DIN 5482	1.5	4,50
BM60002020	GBML32 - F - 1 / 2.0			2.0	4,50
BM60002030	GBML32 - F - 1 / 2.5			2.5	4,50
BM60002040	GBML32 - F - 1 / 3.0			3.0	4,50
BM60002050	GBML32 - F - 1 / 3.5			3.5	4,50
BM60002060	GBML32 - F - 1 / 3.8			3.8	4,50
BM60004040	GBML32 - FR - 1 / 3.0	Femmina FR Female FR 1"3/8 SAE J 1170	Femmina Female A 25x22 DIN 5482	3.0	4,70
BM60004050	GBML32 - FR - 1 / 3.5			3.5	4,70
BM60004060	GBML32 - FR - 1 / 3.8			3.8	4,70

MATERIALE CORPO : ALLUMINIO
BODY MATERIAL : ALUMINIUM

MOLTIPLICATORE PER POMPA GR.3
P.T.O. GEAR BOX FOR GR.3 PUMP

GBML52

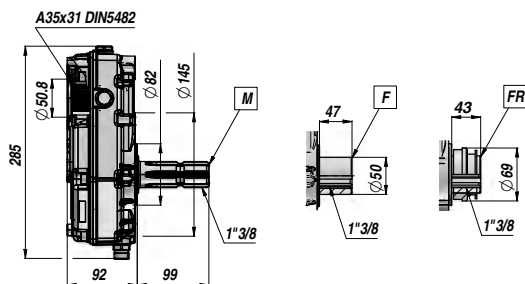

Codice Code	Tipo Type	Albero - Shaft		Rapporto Ratio	kg
		Ingresso - Input	Uscita - Output		
BM70001030	GBML52 - M - 1 / 2.5	Maschio Male 1"3/8 SAE J 1170	Femmina Female A 35x31 DIN 5482	2.6	7,90
BM70001040	GBML52 - M - 1 / 3.0			3.0	7,90
BM70001050	GBML52 - M - 1 / 3.4			3.4	7,90
BM70001060	GBML52 - M - 1 / 3.8			3.8	9,20
BM70002015	GBML52 - F - 1 / 1.5	Femmina Female 1"3/8 SAE J 1170	Femmina Female A 35x31 DIN 5482	1.5	7,10
BM70002020	GBML52 - F - 1 / 2.0			2.0	7,10
BM70002030	GBML52 - F - 1 / 2.5			2.6	7,10
BM70002040	GBML52 - F - 1 / 3.0			3.0	7,10
BM70002050	GBML52 - F - 1 / 3.4			3.4	7,10
BM70002060	GBML52 - F - 1 / 3.8			3.8	8,40
BM70004040	GBML52 - FR - 1 / 3.0	Femmina FR Female FR 1"3/8 SAE J 1170	Femmina Female A 35x31 DIN 5482	3.0	7,30
BM70004060	GBML52 - FR - 1 / 3.8			3.8	8,60

MATERIALE CORPO : ALLUMINIO
BODY MATERIAL : ALUMINIUM

GBR2

NEW!

RIDUTTORE GR.2 - FLANGIA SAE A
GR.2 REDUCTION GEAR - SAE A FLANGE

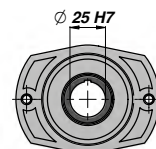
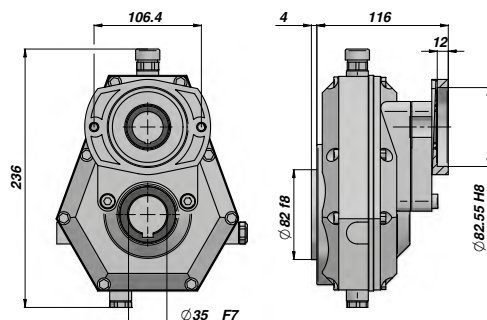
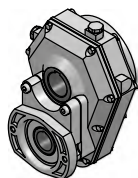

Cilindrico Parallel

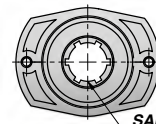

Scanalato Splined

Codice Code	Tipo Type	Albero - Shaft		Rapporto Ratio	kg
		Ingresso - Input	Uscita - Output		
BR95001010	GBR2/SAEA - F25 - 1.5 / 1 - F35	Cilindrico Parallel Ø25	Albero cavo Hollow shaft Ø35	1.5	5,00
BR95001020	GBR2/SAEA - F25 - 2.0 / 1 - F35			2.0	5,00
BR95001030	GBR2/SAEA - F25 - 2.5 / 1 - F35			2.5	5,00
BR95001040	GBR2/SAEA - F25 - 3.0 / 1 - F35			3.0	5,00
BR95001050	GBR2/SAEA - F25 - 3.5 / 1 - F35			3.5	5,00
BR95001060	GBR2/SAEA - F25 - 3.8 / 1 - F35			3.8	5,00
BR95002010	GBR2/SAEA - SAE6B - 1.5 / 1 - F35	Scanalato Splined SAE 6B	Albero cavo Hollow shaft Ø35	1.5	5,00
BR95002020	GBR2/SAEA - SAE6B - 2.0 / 1 - F35			2.0	5,00
BR95002030	GBR2/SAEA - SAE6B - 2.5 / 1 - F35			2.5	5,00
BR95002040	GBR2/SAEA - SAE6B - 3.0 / 1 - F35			3.0	5,00
BR95002050	GBR2/SAEA - SAE6B - 3.5 / 1 - F35			3.5	5,00
BR95002060	GBR2/SAEA - SAE6B - 3.8 / 1 - F35			3.8	5,00

MATERIALE CORPO : ALLUMINIO
BODY MATERIAL : ALUMINIUM

GBR3

NEW!

RIDUTTORE GR.3 - FLANGIA SAE A
GR.3 REDUCTION GEAR - SAE A FLANGE

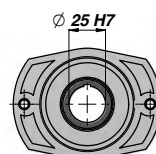
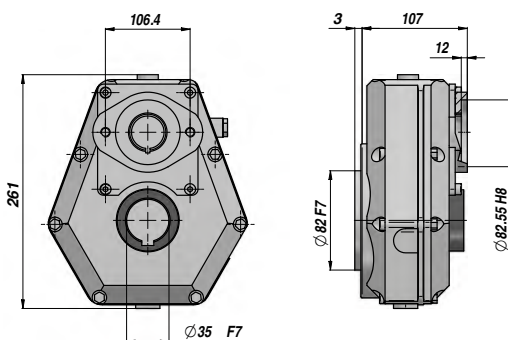
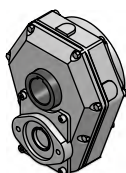

Cilindrico Parallel

Codice Code	Tipo Type	Albero - Shaft		Rapporto Ratio	kg
		Ingresso - Input	Uscita - Output		
BR96001010	GBR2/SAEA - F25 - 1.5 / 1 - F35	Cilindrico Parallel Ø25	Albero cavo Hollow shaft Ø35	1.5	8,50
BR96001020	GBR2/SAEA - F25 - 2.0 / 1 - F35			2.0	8,50
BR96001030	GBR2/SAEA - F25 - 2.5 / 1 - F35			2.5	8,50
BR96001040	GBR2/SAEA - F25 - 3.0 / 1 - F35			3.0	8,50
BR96001050	GBR2/SAEA - F25 - 3.5 / 1 - F35			3.5	8,50
BR96001060	GBR2/SAEA - F25 - 3.8 / 1 - F35			3.8	8,50

MATERIALE CORPO : ALLUMINIO
BODY MATERIAL : ALUMINIUM